

Status: 08/2022



Products need labeling
Print and apply systems



HERMES Q

Made in Germany



Data security in label printing

Modern manufacture sees marking systems work autonomous, interact among each other, with host computers or a plant control unit. Data security is a key issue. The integration of components, their administration and authentication are sensitive tasks demanded from the corporate IT. cab systems developed for printing and applying labels¹ provide proper features by default, fairly protecting your data in a network.



Permissions can be assigned to users and restricted by passwords.



Firmware updates are verified for integrity before installation.



Access to network services (HTTP, FTP, VNC, OPC UA etc.) is possible only for users with authorization. Network services can be switched on or off.



Network protocols can be encrypted using TLS/SSL. To connect securely in a network, a certificate as required is installed in the device ex factory.



Wireless interfaces (WLAN, Bluetooth) can be switched on or off. WPA2 and WPA2 Enterprise levels of security are supported.



Printers in a network can be authorized securely. IEEE 802.1X network standard is supported.



USB slots can be locked and access to external storage media be denied.

All the current cab printing systems are based on the same electronics and firmware. The printer language is the same, so are interfaces and memory. Any further developed operating system or driver is available immediately on every device. Resets to default settings are PIN-protected.

¹ models SQUIX, MACH 4S, EOS 2/5, AXON 1/2, HERMES Q, PX Q, IXOR



Contents

Page 2	cabPROTECT
Pages 4 - 13	HERMES Q
Pages 14 - 15	Software
Pages 16 - 33	Applicators
Page 34	Tools to assemble
Pages 35 - 36	Floor stands
Pages 38 - 42	Delivery program
Page 43	cab product overview

HERMES Q

Printing labels and applying them automatically in production lines

1.1



The slim one

to print small labels

Label printer		HERMES Q2	
Printable resolution	dpi	300	600
Print speed	up to mm/s	300	150
Print width	up to mm	56.9	54.1
Label roll outside diameters	mm	205 / 305	
Label width	up to mm	58	

1.2



The universal one

An industrial bestseller, providing a wide range of accessories

Label printer		HERMES Q4.3		HERMES Q4	
Printable resolution	dpi	200	300	300	600
Print speed	up to mm/s	300	300	300	150
Print width	up to mm	104	108.4	105.7	105.7
Label roll outside diameters	mm	205 / 305			
Label width	up to mm	114			

1.3



The wide one

to print Odette, UCC and GS1 labels in logistics applications

Label printer		HERMES Q6.3	
Printable resolution	dpi	200	300
Print speed	up to mm/s	250	250
Print width	up to mm	168	162.6
Label roll outside diameters	mm	205 / 305	
Label width	up to mm	174	

Sample applications



Label rolls

All units can provide an unwinder for picking up rolls with maximum diameter either 205 mm or 305 mm.



Directions to which dispense labels

All units can be designed for providing labels either to the left or to the right.



Orientations of assembly

All the units can be rotated vertically by at most 360° or assembled in horizontal orientation.

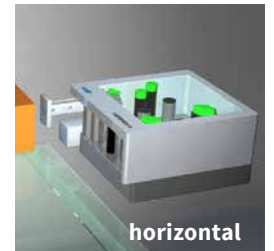
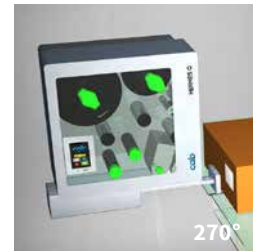
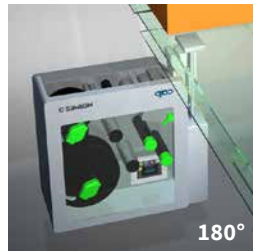
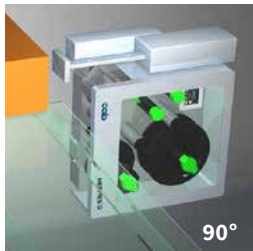
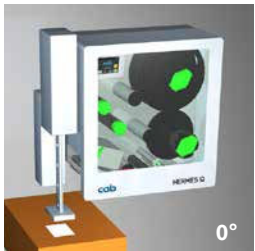

HERMES Q in detail



1 Operation panel

Self-explanatory symbols are on display. The device can thus be operated intuitively and settings be configured easily.

2 Ribbon holder

On the basis of three-part tightening axes, ribbons can be replaced easily and quickly.

3 Rugged metal chassis

It is made of cast aluminum. All the parts are assembled to it.

4 Applicator

It is assembled to hinge pins. It can be pivoted in case of maintenance or if materials have to be replaced.

5 Pressing plungers

One is fixed near the chassis wall. The second one is pushed to the label margin, as far as necessary to evoke a good print image.

6 Print head

Units of the same width are interchangeable. Replacement requires only few steps.

7 Print roller

It can be removed/inserted quickly in cases of cleaning or wear.

8 Peel-off plate

Pivoting improves labels be applied to packages.

9 Label unwinder

A swing arm and an integral brake enable labels be unwound at constant force.

10 Liner rewinder

Subsequent to all the labels been dispensed, the entire liner tape is rewound. On the basis of a three-part tightening axle, a liner tape can be inserted and removed easily.

11 Pulling system

A liner tape is clamped between a draw roller and a pinch roller. Labels are dispensed using feed synchronous to the print roller.

12 Label sensor

Imprint is precisely set on spot on a label and materials ending detected by a transmissive or a reflective sensor.

Accurate imprint

The smaller a label, the higher are the demands regarding the accuracy of an imprint. Print offset can be reduced by ± 0.2 mm using adjustable slip correction.

Print heads



Units of the same width are interchangeable. They are detected by the CPU automatically and calibrated. The print distance to the locating edge can be adjusted.

Major data such as the operational performance, maximum operating temperature and heat energy are recorded on the print head. Data can be read at the factory.

Print heads provided for HERMES Q2, HERMES Q4 - 300, 600 dpi

- sharp-edge print images
- e.g. when printing small fonts and graphics on typeplates
- e.g. when printing on materials requires high energy needs

Print heads provided for HERMES Q4.3, HERMES Q6.3 - 200, 300 dpi
persistent; when labeling in rough settings and thermal direct method

Print rollers



Two types of materials:

Print rollers DR

providing a synthetic rubber coating
They enable highly accurate imprint and are provided by default.

Print rollers DRS

providing a silicone coating
Product life is extra long, taken a higher print offset into account.

Interfaces



- 1 Slot to insert a **SD memory card**
- 2 **2 USB hosts** to connect a service key, USB memory stick, keyboard, barcode scanner, USB Bluetooth adapter, USB WLAN stick, warning light, an external operation panel
- 3 **USB 2.0 Hi-Speed** to connect a PC
- 4 **Ethernet 10/100 Mbit/s**
- 5 **RS232C** 1,200 to 230,400 baud /8 bits
- 6 **Digital I/O interface;** socket connector SUB-D, 25 pins compliant with IEC/EN 61131-2, types 1+3;
All the inputs and outputs are isolated galvanically and protect from reverse polarity. In addition, outputs are short-circuit proof

PNP inputs

Start printing or labeling
Print first label
Reprint
Delete print job
Label removed
Stop printing or labeling
Label feed
Label rotated by 90°
(to be applied by applicator 4214)
Pause
Reset

PNP, NPN outputs

Device ready
Print data available
Initial / upper end position
Paper feed ON
Label in transfer position
Label application / lower end position
Pre-warning to a ribbon ending
Pre-warning to a label web ending
End of a ribbon and/or a label web
Collective error

Option:

- 7 **2 port Ethernet switch 10/100 Mbit/s**

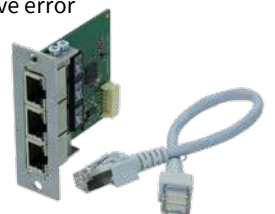







Operation panel

Self-explanatory symbols are on display. The device can thus be operated intuitively and settings be configured easily.

- 1 **LED:** Power ON
- 2 **Status bar:** data reception, record data stream, pre-warning to a ribbon ending, SD memory card / USB memory stick plugged in, Bluetooth, WLAN, Ethernet, USB slave, time
- 3 **Printer status:** ready, pause, number of labels printed in a print job, label in transfer position, awaiting external start signal
- 4 **USB slot** to connect a service key or a memory stick, to transfer data to the IFFS memory

5 Operation

-  Printing and applying labels in individual steps
-  Jump to menu
-  Reprint the latest label
-  Interrupt and continue a print job
-  Stop and delete all print jobs
-  Label feed



Setup options



Print parameters

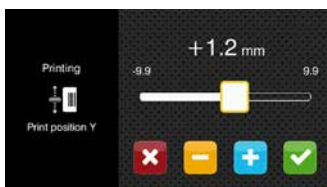

Print offset Y

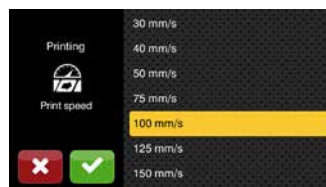

Print speeds

Landscape or portrait display, depending from the orientation of assembly



Printer rotated by 90°



Video tutorials

External operation panel

If the operation panel of a printer cannot be accessed, an additional external one can be plugged.

Same functionality as on the printer

Landscape or portrait mode

Operability as desired on the external operation panel or on the printer

Printer connectivity: USB 2.0 Hi-Speed device

















- 1 **LED:** Power ON
- 2 **USB port** to plug a service key or a memory stick, to transfer data to the IFFS memory
- 3 **Connecting USB cable** for power supply
cab provides specified cables. Lengths are 1.8 m to 16 m.



Accessories

Accessorial products are plugged or screwed to a printer by the customer.

Pos.	Designation	roll Ø	205	305	1.1	1.2		1.3
					HERMES Q2	HERMES Q4.3	HERMES Q4	HERMES Q6.3
2.1	SD memory card		●	●	<input type="checkbox"/>	<input type="checkbox"/>	<input type="checkbox"/>	<input type="checkbox"/>
2.2	USB memory stick		●	●	<input type="checkbox"/>	<input type="checkbox"/>	<input type="checkbox"/>	<input type="checkbox"/>
2.3	USB WLAN stick		●	●	<input type="checkbox"/>	<input type="checkbox"/>	<input type="checkbox"/>	<input type="checkbox"/>
2.4	USB WLAN stick including a rod antenna		●	●	<input type="checkbox"/>	<input type="checkbox"/>	<input type="checkbox"/>	<input type="checkbox"/>
2.5	USB Bluetooth adapter		●	●	<input type="checkbox"/>	<input type="checkbox"/>	<input type="checkbox"/>	<input type="checkbox"/>
2.6	Product sensor, 3 pins		●	●	-	<input type="checkbox"/>	<input type="checkbox"/>	<input type="checkbox"/>
2.7	Product sensor, 25 pins		●	●	<input type="checkbox"/>	<input type="checkbox"/>	<input type="checkbox"/>	<input type="checkbox"/>
2.8	I/O interface connector SUB-D, 25 pins		●	●	<input type="checkbox"/>	<input type="checkbox"/>	<input type="checkbox"/>	<input type="checkbox"/>
2.9	Warning light		●	●	<input type="checkbox"/>	<input type="checkbox"/>	<input type="checkbox"/>	<input type="checkbox"/>
2.10	External operation panel		●	●	<input type="checkbox"/>	<input type="checkbox"/>	<input type="checkbox"/>	<input type="checkbox"/>
	Connecting USB cable		●	●	<input type="checkbox"/>	<input type="checkbox"/>	<input type="checkbox"/>	<input type="checkbox"/>
2.11	Label selection - I/O box		●	●	<input type="checkbox"/>	<input type="checkbox"/>	<input type="checkbox"/>	<input type="checkbox"/>
2.12	Hand switch TR2		●	●	<input type="checkbox"/>	<input type="checkbox"/>	<input type="checkbox"/>	<input type="checkbox"/>
2.13	Foot switch		●	●	<input type="checkbox"/>	<input type="checkbox"/>	<input type="checkbox"/>	<input type="checkbox"/>
2.14	Connecting RS232 C cable		●	●	<input type="checkbox"/>	<input type="checkbox"/>	<input type="checkbox"/>	<input type="checkbox"/>
2.15	Scanner CC200		●	●	<input type="checkbox"/>	<input type="checkbox"/>	<input type="checkbox"/>	<input type="checkbox"/>

2.1		SD memory card
2.2		USB memory stick
2.3		USB WLAN stick 2.4 GHz 802.11b/g/n hotspot or infrastructure mode
2.4		USB WLAN stick including a rod antenna to extend the range of operation 2.4 GHz 802.11b/g/n + 5 GHz 802.11a/n/ac hotspot or infrastructure mode
2.5		USB Bluetooth adapter
2.6		Product sensor, 3 pins to be attached to a front side applicator, a vacuum belt applicator or an air jet box. Labels are triggered to be applied as soon as a product has been detached, e.g. on a conveyor belt.
2.7		Product sensor, 25 pins Labels are triggered to be applied as soon as a product has been detached, e.g. on a conveyor belt.
2.8		I/O interface connector SUB-D, 25 pins All control signals can be attached to the I/O interface using clamping screws.
2.9		Warning light <i>Available again as of quarter 1/2023</i> In addition to the information indicated on the display of a printer, states are signalled. Red Collective error Yellow Pre-warning to a label web or a ribbon ending Green Device ready USB cable (1 m) to connect to HERMES Q Assembly materials are provided for vertical printer installation only. 1 Chassis assembly 2 Bracket assembly
2.10		External operation panel If the operation panel of a printer cannot be accessed, an additional external one can be plugged. Same functionality as on the printer Landscape or portrait mode Operability as desired on the external operation panel or on the printer
		Printer connectivity: USB 2.0 Hi-Speed device cab provides specified connecting USB cables for power supply. Lengths are 1.8 m to 16 m.
2.11		Label selection - I/O box A maximum of 16 different labels can be selected from a memory card by a master control unit, e.g. PLC.
2.12		Hand switch TR2 to be attached to the I/O interface
2.13		Foot switch to be attached to the I/O interface
2.14		Connecting RS232 C cable 9/9 pins, 3 m
2.15		Scanner CC200 provided on request

Options are parts or units to perform special functions. They are assembled to a printer in addition to or instead of standards.

If order implies options be assembled ex factory, the part numbers of such printers and options are added by .250. Options delivered separately are added by .001.

Pos.	Designation	roll Ø	205	305	HERMES Q2	HERMES Q4.3	HERMES Q4	HERMES Q6.3	.250	.001
3.1	Automatic ribbon saving		●	●	-	□	□	□	●	-
3.2	Label unwinder K40		●	●	□	□	□	□	●	●
3.3/3.4	Adapters 40/50 and 76/100		●	●	□	□	□	□	●	●
3.5	Spacers		●	-	□	□	□	-	●	●
3.6	Margin stop 10		●	-	□	□	□	□	●	●
3.7	Cover		●	-	□	□	□	□	●	●
3.8	Print head pressure system, reduced force		●	●	□	□	-	□	●	●
3.9	Extended peel-off plate (+10 mm)		●	●	□	□	□	□	●	●
3.10	Print roller DRS		●	●	□	□	□	□	●	●
3.11	Antistatic brush		●	●	□	□	□	-	●	●
3.12	Draw roller ZS		●	●	□	□	□	□	●	●
3.13	2 port Ethernet switch 10/100 Mbit/s		●	●	□	□	□	□	●	●
3.14	Label sensor, modified		●	●	□	-	-	-	●	●



3.1

assembly
ex factory only

Automatic ribbon saving

Use is recommended in cases of at least 60 mm unprinted area on a label. While labels are fed, the print head is lifted and the ribbon stopped, resulting in less material consumption.



Label unwinder K40

to process label rolls having a core diameter of 40 mm



Adapter 40/50

to pick up label rolls having a core diameter of 50 mm and minimum widths of 20 mm. One adapter is sufficient if material width does not exceed 50 mm.

Operate only with a label unwinder K40.



Adapter 76/100

to pick up label rolls having a core diameter of 100 mm and minimum widths of 20 mm. One adapter is sufficient if material width does not exceed 50 mm.



Spacers

to process narrow labels provided on liners ≤ 20 mm wide, wound on a roll or a reel.

Ribbon protruding on both sides prevents from wrinkling. The label guidance is therefore offset by 7 mm from the middle wall with spacers. A modified label sensor is included on delivery.

Reel plate wall thickness 1 - 2 mm

Label sensor, modified

Provided for labels requiring a sensor distant up to 26 mm to the locating edge. This sensor cannot be fixed with a screw.



Margin stop 10

to guide narrow labels provided on a liner 10 - 24 mm wide, wound on a roll (no reels) having a core diameter of 76 mm.

Operate only with a spacer

Options

3.7

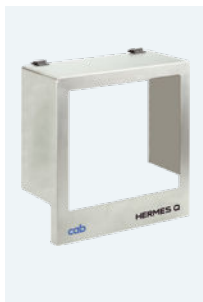

Cover

to prevent from contamination and contact

Maximum outside diameter for label rolls is 205 mm

If the tamp-on pad of an applicator immerses more than 25 mm, the cover must be adapted.

Assembly in vertical orientation, rotated by $\pm 90^\circ$ or horizontally

3.8



Print head pressure system, reduced force

Thermal direct printing requires less pressure on a print head.

Reduced force results in a decrease of wear. Product life extends.

Thermal direct printing only

3.9



Extended peel-off plate (+10 mm)

Recommended

- if labels are picked up by a robotic arm,
- if readable area is required for scanning,
- when installing an antistatic brush

3.10



Print roller DRS

Silicone coating enables an extra long product life, taken a higher print offset into account

3.11



Antistatic brush

Electrostatic charge is reduced when plastic labels are printed and peeled off.

Operate only with an extended peel-off plate.

3.12



Draw roller ZS

Made of steel, to avoid tension on a liner tape:

- if label height exceeds 150 mm
- when peeling off without backfeed
- if thick liner materials are processed
- when applying labels using a demand module 5114/16

3.13



2 port Ethernet switch 10/100 Mbit/s

to connect another terminal device in a joint network.

Signals are looped through.

Technical data

● typical ■ standard □ option

Label printer		type	HERMES Q2		HERMES Q4.3		HERMES Q4		HERMES Q6.3	
Printing method	Thermal transfer		●	●	●	●	●	●	●	●
	Thermal direct		-	-	●	●	-	-	●	●
Printable resolution	dpi		300	600	200	300	300	600	200	300
Print speed	up to mm/s		300	150	300	300	300	150	250	250
Print width	bis mm		56.9	54.1	104	108.4	105.7	105.7	168	162.6
Direction to which dispense labels			L = to the left, R = to the right							
Print distance to the locating edge	mm		1	1	1	1	1	1	1	1
incl. automatic ribbon saving L/R mm			-	-	2.2/1.6	0/-0.7	1/1	1/1	0.2/0.2	2.9/2.9
Materials										
Labels			paper, PET, PE, PP, PI, PVC, PU, acrylate, Tyvec							
on a roll			●		●		●		●	
on a reel			●		-		-		-	
Labels ¹⁾	Width	mm	4 - 58		10 - 114		10 - 114		46 - 174	
	Height	from mm	3		4		4		6	
	Thickness	up to mm	0.60		0.60		0.60		0.60	
Liner tape	Width if operating a roll	mm	24 - 62		24 - 118		24 - 118		50 - 178	
	Width ²⁾ if operating a reel or a roll	mm	10 - 24		-		10 - 24		-	
	Thickness	up to mm	0.16		0.16		0.16		0.16	
Roll unwinder	Outside roll diameter	up to mm	205 / 305		205 / 305		205 / 305		205 / 305	
	reel diameter	up to mm	205		-		-		-	
	Core diameter	mm	76							
	Winding		outside or inside							
Roll rewinder	Outside diameter	up to mm	155 / 205							
	Core diameter	mm	76							
Ribbon ³⁾	Ink side		outside or inside							
	Roll diameter	up to mm	90							
	Core diameter	mm	25.4							
	Length	up to m	600							
	Width	mm	25 - 67		25 - 114		25 - 114		50 - 170	
	Automatic ribbon saving		-		□		□		□	
Printer dimensions and weights										
Width	mm		207		260		260		320	
Height	roll diameters 205 / 305	mm	400 / 430							
Depth	roll diameters 205 / 305	mm	400 / 500							
Weight	roll diameters 205 / 305	approx. kg	15 / 16		16 / 17		16 / 17		20	
Label sensor indicating positions										
Transmissive sensor	detecting		labels, punch marks or print marks, as well as materials ending							
Reflective sensor	bottom reflex	detecting	print marks on non-transparent liners, as well as materials ending							
Sensor distance to the locating edge	standard	mm	2 - 12		2 - 60		2 - 60		2 - 60	
	modified	mm	2 - 26							
Material passage	mm		2							
Electronics										
32-bit processor	MHz		800							
RAM	MB		256							
IFFS memory	MB		50							
Slot to insert a memory card (SDHC, SDXC)			■							
Battery to display date and real time			■							
Data (e.g. serial numbering) preserved if power turns off			■							
Interfaces										
RS232C	1,200 to 230,400 baud / 8 bits		■							
USB 2.0 Hi-Speed to connect a PC			■							
Ethernet	10/100 Mbit/s		LPD, RawIP printing, SOAP Webservice, OPC UA, WebDAV DHCP, HTTP/HTTPS, FTP/FTPS, TIME, NTP, Zeroconf, SNMP, SMTP, VNC							
1 USB host on the operation panel	provided for		a service key, USB memory stick, USB WLAN stick, USB Bluetooth adapter							
2 USB hosts on the back of the device	provided for		a keyboard, barcode scanner, USB memory stick, warning light, USB WLAN stick, USB WLAN stick including a rod antenna, USB Bluetooth adapter, an external operation panel							
USB host	24 VDC, to connect a peripheral device		■							
Digital I/O interface	10 inputs / 11 outputs		■							
2 port Ethernet switch	10/100 Mbit/s		□							

¹⁾ Limitations can occur when processing small labels, thin materials or materials using a strong adhesive. Critical applications need testing.

²⁾ Spacers attached to the label unwinder and the unit rewinding the liner tape help feeding the ribbon centered above the labels.

³⁾ The ribbon must correspond at least to the width of the liner tape.

Technical data

■ standard □ option

Operating data	
Voltage	100-240 VAC, 50/60 Hz, PFC
Power consumption	standby <10 W / typical 150 W / up to 300 W
Temperature / Operation	+5 - 40°C / 10 - 85 %, not condensing
humidity	Stock 0 - 60°C / 20 - 85 %, not condensing
	Transport -25 - 60°C / 20 - 85 %, not condensing
Approvals	CE, FCC Class A, ICES-3, cULus, CB, EAC, RCM Mark, CCC, CoC Mexico, BSMI Mark, KC Mark
Operation panel	
Colored LCD touch display	Screen diagonal " 4,3 Resolution Width x Height px 480 x 272
Setup options	
Print Labels Ribbon Peel off Apply label Interfaces Error	Region: - Language - Country - Keyboard - Time zone Time Display: - Brightness - Power saving mode - Orientation Interpreter
Status bar	
	Data reception Bluetooth Record data stream WLAN Pre-warning to a ribbon ending Ethernet SD memory card plugged in USB slave USB memory stick plugged in Time
Monitoring	
	Ribbon Direction of winding Pinch roller open Pre-warning Peripheral error Material ending Labels Pre-warning Material ending Print head Voltage Temperature open
Test routines	
System diagnostics	on start-up, the print head is also detected
Information display, print test, analysis	Status printout Test grid List of fonts Label profile List of devices List of events WLAN status Monitor mode Record print data on a memory card
Status reports	- Printout of device settings, e.g. durations of printing and hours in operation - Device status request triggered by software command - Display of network errors, missing links, barcode errors, peripheral errors, etc.
Fonts	
Provided internally	5 bitmap fonts: 7 vector fonts: 12 x 12 dots AR Heiti Medium GB-Mono 16 x 16 dots CG Triumvirate Condensed Bold 16 x 32 dots Garuda OCR-A HanWangHeiLight OCR-B Monospace 821 Swiss 721 Regular, Bold
To be stored	TrueType fonts
Character sets	Windows-1250 to -1257 DOS 437, 737, 775, 850, 852, 857, 862, 864, 866, 869 EBCDIC 500 ISO 8859-1 to -10 and -13 to -16 WinOEM 720 UTF-8 MacRoman DEC MCS KOI8-R Western European Cyrillic Eastern European Greek Chinese, simplified Latin Chinese, traditional Hebrew Thai Arabic

Fonts	
Bitmap fonts	Widths and heights 1 - 3 mm Zoom factors 2 to 10 Orientations 0°, 90°, 180°, 270°
Vector / TrueType fonts	Widths and heights 0,9 - 128 mm Continuous zoom 360° orientation in steps of 1°
Font styles	bold, italic, underlined, outline, inverse - depending from the font type
Character spacing	variable or monospace for fixed spacing
Graphics	
Elements	lines, arrows, rectangles, circles, ellipses - filled or filled with fading
Formats	PCX, IMG, BMP, TIF, MAC, GIF, PNG
Codes	
1D barcodes (linear)	Code 39, Code 93 Interleaved 2/5 Code 39 Full ASCII Ident and routing code Code 128 A, B, C of Deutsche Post EAN 8, 13 Codabar EAN/UCC 128/GS1-128 JAN 8, 13 EAN/UPC Appendix 2 MSI EAN/UPC Appendix 5 Plessey FIM Postnet HIBC RSS 14 UPC A, E, E0
2D and stacked codes	DataMatrix DataMatrix Rectangle Extension QR code Micro QR code GS1 QR code GS1 DataMatrix PDF 417 Micro PDF 417 UPS MaxiCode GS1 DataBar Aztec Codablock F Dotcode RSS 14 truncated, limited, stacked, stacked omni-directional Heights, modular widths and ratio are variable Orientations 0°, 90°, 180°, 270° Check digit, plain text printout and start/stop coding are options depending from the code type.
Software	
Label software	cablabel S3 Lite ■ cablabel S3 Viewer ■ cablabel S3 Pro □ cablabel S3 Print □
Running also with	CODESOFT NiceLabel BarTender
Stand-alone operation	■
Windows printer drivers WHQL-certified for	Windows Vista Server 2008 Windows 7 Server 2008 R2 Windows 8 Server 2012 Windows 8.1 Server 2012 R2 Windows 10 Server 2016 Server 2019 ■
Apple printer drivers	at least Mac OS X 10.6 ■
Linux printer drivers	at least CUPS 1.2 ■
Programming	JScript printer language ■ abc Basic Compiler ■ ZPL II (Datastream be tested in advance) □
Integration	SAP ■ Database Connector ■
Administration	Printer control ■ Configuration on the Intranet / Internet ■

cab uses free and Open Source software in its products.
For information see www.cab.de/opensource

cablabel S3 software

Design, print, administrate

cablabel S3 opens up the full potential of cab devices. Creating a label is the first step. cablabel S3 adapts to requirements easily using a modular design. Plug-ins like the JScript Viewer support native JScript programming, as well as other features. The designer user interface and the JScript code synchronize in real time. The Database Connector and other special features can be integrated, so are barcode verifiers.



For further information see
www.cab.de/en/cablabel

Stand-alone printing

A printer can select and print labels even when the system is disconnected from a host.

Labels are designed using software such as cablabel S3 or a text editor on a PC. Label formats, texts, graphics and data taken from a database are transferred to a memory card, a USB memory stick or the internal IFFS memory.

Only variable data are sent to the printer using a keyboard, a barcode scanner, scale or another host system and/or are recalled from a host by the Database Connector and printed.



OPC UA

The latest cab printers are ready to interact with machines and components of different manufacturers in industrial plants.

An OPC UA server and a client are part of the firmware.

The server enables a printer be configured and controlled. Dynamic print data can be edited using a defined programming interface.

The integral client enables reading data fields from other machines ready for OPC UA, as well as transferring data to a label. No additional software is needed.



Printer control

Drivers

cab provides 32 / 64-bit drivers to control a printer with software other than cablabel S3. Running the drivers requires at least operating systems Windows Vista, Mac OS 10.6, Linux CUPS 1.2.



Windows¹⁾ drivers

compliant to WHQL standards



Mac OS X²⁾ drivers

based on CUPS



Linux³⁾ drivers

based on CUPS

Free download on www.cab.de/en/support

Programming



JScript

To control a printer, cab developed the embedded JScript programming language. Free manual download on www.cab.de/en/programming



abc Basic Compiler

An integral part of the firmware, it adds to JScript in terms of programming a printer before data are edited for processing. For example, external printer languages can be replaced without intervening in the print job in process. Data may be transferred also from other systems, such as scales, barcode scanners or PLC.

Integration



Printer Vendor Program

As a member in this program, cab developed a replace method by which cab printers can be controlled from SAP⁴⁾R/3 using SAPScript. Only variable data are sent by a host system to the printer. Data such as pictures and fonts which had been transferred to a local memory (IFFS, memory card, etc.) before, are collected.

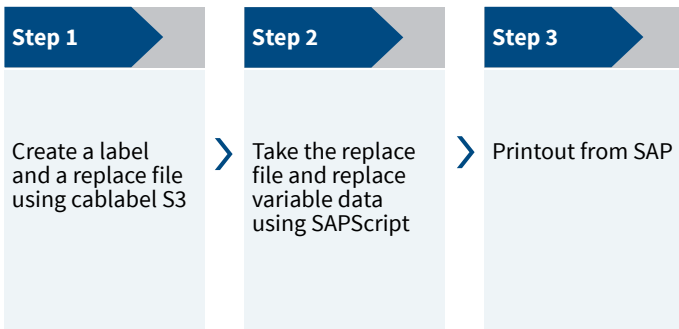

¹⁾ Windows is a registered trademark of the Microsoft Corporation
²⁾ MAC OS X is a registered trademark of Apple Computer, Inc.
³⁾ models SQUIX, MACH 4S, EOS, HERMES Q, PX Q only
⁴⁾ SAP and all its corresponding logos are trademarks or registered trademarks of SAP SE

Printer administration

Configuration on the Intranet / Internet

cab printers integrate a HTTP and FTP server. A printer can be controlled and configured, firmware updated and memory cards managed using a standard web browser or FTP client. Administrators and operators are notified of states, warnings and errors via email or datagrams, based on a SNMP/SMTP client. Time and date are synchronized by a time server.



Database Connector

Printers connected to a network are enabled to access data directly from a central ODBC / OLEDB database and transfer it to a label. While labels are printed, data can be rewritten to the database.



Applicators



HERMES Q has been designed for printing and applying labels automatically in production lines. Labels are applied by applicators, using transfer modules to roll, blow or tamp labels on products or packages.

- 1 Long product life**
The precise and low-wear linear guide is using a ball bearing chain.
- 2 Products of variable heights**
Labels can be applied on different heights using a stroke cylinder. Its standard lengths are 200, 300 and 400 mm. Further lengths can be provided on request.
- 3 Protective chassis**
is a standard to protect the cylinder and the guide. It can be provided adapted to the product jig on a labeling workstation.
- 4 Highly reliable processes**
Support air and intake air can be defined, so can stroke speed. Sensor control
- 5 Label application**
in real time. Small or large labels, 4 to 250 mm high and 4 to 174 mm wide, can be processed using an applicator.



Pressure-reducing valve
It reduces the pressure exerted by the stroke cylinder to a product.

- 6 Pivoting applicator**
The print mechanics can be accessed quickly and easily in case of maintenance or if materials have to be replaced.

Applicators and transfer modules

Overview

		HERMES Q			Labels are transferred using a													
		2	4	6.3	Universal pad	Tamp-on pad	Tamp-on pad, providing a damping layer	Tamp-on pad, providing a label stop	Blow-on pad	Form pad	Universal pad, spring-mounted	Tamp-on pad, spring-mounted	Roll-on pad	Corner-wrap pad	Demand module	Vacuum belt	Template	
Applicators		Order code			Page	11	11	12	61	21	88	31	31	41	51	—	—	90
Product marking	Swing applicator	3214	3214		18	—	F	F	F	□	—	—	—	—	—	—	—	—
	Stroke applicator	4114	4114		19/20	—	F	F	F	□	□	—	—	—	—	—	—	—
				4116		19/20	—	F	F	F	—	□	—	—	—	—	—	—
	Stroke turn applicator	4214	4214		21	—	F	F	F	□	—	—	—	—	—	—	—	—
	Stroke applicator	4414	4414		22	—	F	F	F	—	—	—	—	—	—	—	—	—
	Swing stroke applicator	4514	4514		23	—	—	—	—	□	—	—	—	—	—	—	—	—
	Flag applicator		4712		24	—	—	—	—	—	□	—	—	—	—	—	—	
Package marking	Front side applicator		3014		25	—	□	—	—	□	—	—	□	—	—	—	—	
				3016		25	—	□	—	—	—	—	□	—	—	—	—	
	Stroke applicator		4014		26/27	□	F	—	—	□	—	□	□	□	—	—	—	
				4016		26/27	—	□	—	—	—	—	□	□	—	—	—	
	Stroke blow applicator		4614		28	—	—	—	—	□	—	—	—	—	—	—	—	
	Demand module	5112	5114	5116	29	—	—	—	—	—	—	—	—	—	—	□	—	
	Vacuum belt applicator		5314	5316		30	—	—	—	—	—	—	—	—	—	—	□	—
			5414	5416		31	—	—	—	—	—	—	—	—	—	—	—	□
Air jet box		6114		32	—	—	—	—	—	—	—	—	—	—	—	—	□	

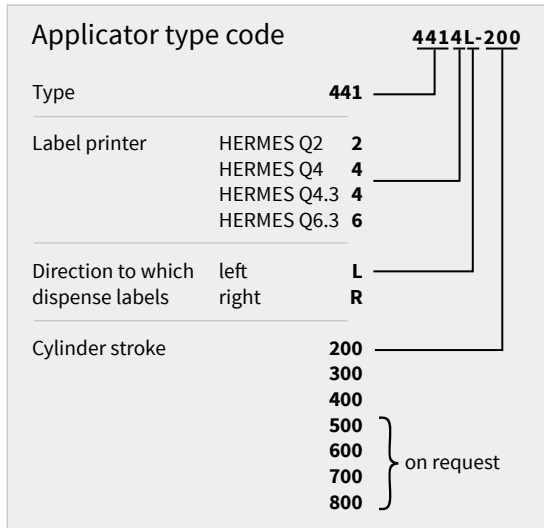

F Tamp-on pad immersing in the surface along a label

For depths of immersion see the specified technical data of an applicator.

If an applicator immerses more than 25 mm, the cover of HERMES Q must be adapted.

Product marking

Swing applicator 3214

Labels very small or midsized can be applied in real time, preferably from the side.

The pad locates in front of the peel-off plate. It picks up a label while it is being printed. A rotary cylinder pivots into position. The label is transferred to a product by a stroke cylinder. Rotary angles and linear hubs are adjustable.



4.1



Accessories

5.13 Blow tube

5.14 Unit to regulate compressed air



Tamp-on pad

Labels are precisely tamped on plane surfaces. Recessed levels are possible as well.

Tamp-on pad, providing a damping layer

When applying labels to hard surfaces, the noise level is reduced. It benefits also in cases of rough structures or little unevenness.

Tamp-on pad, providing a label stop

It enables small labels be applied exactly on spot to a product.

Blow-on pad

It benefits when labels have to be applied to sensitive surfaces or products in motion. Labels are blown on by a blast of air. Stroke cylinder adjustment enables bridging distances of 5 to 10 mm to the surface of a product.

	Tamp-on pad	Tamp-on pad, providing a damping layer	Tamp-on pad, providing a label stop	Blow-on pad
Technical data	3214 L/R 11 F	3214 L/R 12 F	3214 L/R 61 F	3214 L/R 2100
Label widths operating a HERMES Q2 mm	4 - 58	10 - 58	10 - 58	10 - 58
HERMES Q4/Q4.3 mm	10 - 114	10 - 114	10 - 114	10 - 80
Label heights operating a HERMES Q2 mm	5 - 80	8 - 80	5 - 80	10 - 80
HERMES Q4/Q4.3 mm	8 - 80	8 - 80	8 - 80	10 - 80
State of a product at rest			■	
at the moment a label is applied in motion	-	-	-	■
Label application from the side			■	
Product heights uniform			■	
Distance of a product to the peel-off plate mm			250 - 280	
Linear guidance, horizontal mm			5 - 30	
Pivot angles			45° - 95°	
Depth of a pad immersing F up to mm	30	30	30	-
Compressed air bar			4.5	
Cycle rate ¹⁾ labels/min approx.			20	

¹⁾ calculated using labels 40 mm high and a print speed of 100 mm/s

Product marking

Stroke applicators 4114, 4116

Labels very small or midsized can be applied in real time from all sides.

The pad locates in front of the peel-off plate. It picks up a label while it is being printed. Powered by a short stroke cylinder, the pad is brought into position in horizontal direction. The label is transferred to a product by a stroke cylinder. The length of the stroke cylinder defines the maximum distance of a product to the peel-off plate.



Accessories

5.13 **Blow tube**

5.14 **Unit to regulate compressed air**

5.17 **Pressure-reducing valve**

4.2



Tamp-on pad

Labels are precisely tamped on plane surfaces. Recessed levels are possible as well.

Tamp-on pad, providing a damping layer

When applying labels to hard surfaces, the noise level is reduced. It benefits also in cases of rough structures or little unevenness.

Tamp-on pad, providing a label stop

It enables small labels be applied exactly on spot to a product.

Blow-on pad

It benefits when labels have to be applied to sensitive surfaces or products in motion. Labels are blown on by a blast of air. Stroke cylinder adjustment enables bridging distances of 5 to 10 mm to the surface of a product.

			Tamp-on pad	Tamp-on pad, providing a damping layer	Tamp-on pad, providing a label stop	Blow-on pad
Technical data			4114, 4116 L/R 11 F	4114, 4116 L/R 12 F	4114, 4116 L/R 61 F	4114 L/R 2100
Label widths operating a	HERMES Q2	mm	4 - 58	10 - 58	10 - 58	10 - 58
	HERMES Q4/Q4.3	mm	10 - 114	10 - 114	10 - 114	10 - 114
	HERMES Q6.3	mm	50 - 174	50 - 174	50 - 174	-
Label heights operating a	HERMES Q2	mm	4 - 80	8 - 80	4 - 80	10 - 80
	HERMES Q4/Q4.3	mm	8 - 80	8 - 80	8 - 80	10 - 80
	HERMES Q6.3	mm	8 - 80	8 - 80	8 - 80	-
State of a product	at rest			■		
at the moment a label is applied	in motion	-	-	-	-	■
Label applications	from the top			■		
	from below			■		
	from the side			■		
Product heights	uniform		-	-	-	■
	variable		■	■	■	-
Short stroke cylinder, horizontal	mm				10	
Distance of a product to the bottom of the unit using a cylinder stroke of	200	up to mm	135	135	135	140
	300	up to mm	235	235	235	240
	400	up to mm	335	335	335	340
Depth of a pad immersing F ¹⁾	up to mm	110	110	110	110	-
Compressed air	bar				4.5	
Cycle rate ²⁾	labels/min approx.				30	

¹⁾ If an applicator immerses more than 25 mm, the cover of HERMES Q must be adapted.

²⁾ calculated using a stroke of 100 mm below the unit, labels 40 mm high, a print speed of 100 mm/s

Product marking

Stroke applicators 4114, 4116

Labels very small or midsized can be applied in real time from all sides.

The pad locates in front of the peel-off plate. It picks up a label while it is being printed. Powered by a short stroke cylinder, the pad is brought into position in horizontal direction. The label is transferred to a product by a stroke cylinder. The length of the stroke cylinder defines the maximum distance of a product to the peel-off plate.



Accessories

5.13 **Blow tube**

5.14 **Unit to regulate compressed air**

5.17 **Pressure-reducing valve**

4.2



Form pad

Labels are precisely applied to cylindric objects, inclined or curved surfaces. Curved form pads prevent from blistering on very smooth and plane surfaces. 200° maximum label wrapping on cylindric objects

Technical data		Form pad
		4114, 4116 L/R 8800
Label widths operating a HERMES Q2	mm	10 - 58
HERMES Q4/Q4.3	mm	10 - 114
HERMES Q6.3	mm	50 - 174
Label heights	mm	8 - 80
State of a product at the moment a label is applied	at rest	■
Label applications	from the top	■
	from below	■
	from the side	■
Product heights	variable	■
Short stroke cylinder, horizontal	mm	10
Distance of a product to the bottom of the unit using a cylinder stroke	200 up to mm	135
	300 up to mm	235
	400 up to mm	335
Compressed air	bar	4.5
Cycle rate ¹⁾	labels/min approx.	20

¹⁾ calculated using a stroke of 100 mm below the unit, labels 40 mm high, a print speed of 100 mm/s
If the height of the form pad exceeds 25 mm, the cover of HERMES Q must be adapted.

Product marking

Stroke turn applicator 4214

Labels very small or midsized can be applied in real time from all sides whenever the unit is difficult to install.

The pad locates in front of the peel-off plate. It picks up a label while it is being printed. Powered by a rotary cylinder, the pad pivots into position by at most 180° in horizontal direction. The label is transferred to a product by a stroke cylinder. The length of the stroke cylinder defines the maximum distance of a product to the peel-off plate.



Accessories

5.13 Blow tube

5.14 Unit to regulate compressed air

5.17 Pressure-reducing valve

4.3



Tamp-on pad

Labels are precisely tamped on plane surfaces. Recessed levels are possible as well.

Tamp-on pad, providing a damping layer

When applying labels to hard surfaces, the noise level is reduced. It benefits also in cases of rough structures or little unevenness.

Tamp-on pad, providing a label stop

It enables small labels be applied exactly on spot to a product.

Blow-on pad

It benefits when labels have to be applied to sensitive surfaces or products in motion. Labels are blown on by a blast of air. Stroke cylinder adjustment enables bridging distances of 5 to 10 mm to the surface of a product.

		Tamp-on pad	Tamp-on pad, providing a damping layer	Tamp-on pad, providing a label stop	Blow-on pad
Technical data		4214 L/R 11 F	4214 L/R 12 F	4214 L/R 61 F	4214 L/R 2100
Label widths operating a HERMES Q2	mm	4 - 58	10 - 58	10 - 58	10 - 58
	HERMES Q4/Q4.3			10 - 80	
Label heights operating a HERMES Q2	mm	4 - 40	8 - 40	4 - 40	10 - 40
	HERMES Q4/Q4.3	8 - 40	8 - 40	8 - 40	10 - 40
State of a product at the moment a label is applied	at rest			■	
	in motion	-	-	-	■
Label applications	from the top			■	
	from below			■	
	from the side			■	
Product heights	uniform	-	-	-	■
	variable	■	■	■	-
Rotary angle, horizontal	90°, 0°			■	
	180° if labels are no more than 15 mm high				
Distance of a product to the bottom of the unit using a cylinder stroke of 200	up to mm	135	135	135	140
	300	235	235	235	240
	400	335	335	335	340
Depth of a pad immersing F ¹⁾	up to mm	65	65	65	-
Compressed air	bar			4.5	
Cycle rate ²⁾	labels/min approx.			20	

¹⁾ If an applicator immerses more than 25 mm, the cover of HERMES Q must be adapted.

²⁾ calculated using a stroke of 100 mm below the unit, labels 40 mm high, a print speed of 100 mm/s

Product marking

Stroke applicator 4414

Labels very small or midsized can be applied in real time from all sides. Positions to which labels shall be applied can be adjusted in directions x and y.

The pad locates in front of the peel-off plate. It picks up a label while it is being printed. Powered by two short stroke cylinders, the pad is brought into position. The label is transferred to a product by a stroke cylinder. The length of the stroke cylinder defines the maximum distance of a product to the peel-off plate.



Accessories

5.13 **Blow tube**

5.14 **Unit to regulate compressed air**

5.17 **Pressure-reducing valve**



Tamp-on pad

Labels are precisely tamped on plane surfaces. Recessed levels are possible as well.

4.4



Tamp-on pad, providing a damping layer

When applying labels to hard surfaces, the noise level is reduced. It benefits also in cases of rough structures or little unevenness.

Tamp-on pad, providing a label stop

It enables small labels be applied exactly on spot to a product.

	Tamp-on pad	Tamp-on pad, providing a damping layer	Tamp-on pad, providing a label stop
Technical data	4414 L/R 11 F	4414 L/R 12 F	4414 L/R 61 F
Label widths operating a HERMES Q2	mm	4 - 58	10 - 58
HERMES Q4/Q4.3	mm		10 - 114
Label heights operating a HERMES Q2	mm	4 - 80	8 - 80
HERMES Q4/Q4.3	mm		8 - 80
State of a product at the moment a label is applied	at rest	■	
Label applications	from the top	■	
	from below	■	
	from the side	■	
Product heights	variable	■	
Short stroke cylinders, horizontal direction x	mm	3 - 7	
direction y	mm	11 - 15	
Distance of a product to the bottom of the unit using a cylinder stroke of 200	up to mm	135	
	300 up to mm	235	
	400 up to mm	335	
Depth of a pad immersing F ¹⁾	up to mm	90	
Compressed air	bar	4.5	
Cycle rate ²⁾	labels/min approx.	25	

¹⁾ If an applicator immerses more than 25 mm, the cover of HERMES Q must be adapted.

²⁾ calculated using a stroke of 100 mm below the unit, labels 40 mm high, a print speed of 100 mm/s

Product marking

Swing stroke applicator 4514

Labels can be applied in real time from all sides on inner surfaces of profiles and pipes. Stroke cylinder adjustment enables labels be transferred exactly to their dedicated spots.

The pad locates in front of the peel-off plate. It picks up a label while it is being printed. Powered by a rotary cylinder, the pad pivots to the level on which the label shall be applied. The label is moved to the point of transfer by a stroke cylinder.



Accessories

5.13 Blow tube

5.14 Unit to regulate compressed air

4.5



Blow-on pad

Labels are blown on a product surface by a blast of air, bridging a distance of 5 to 10 mm.

Technical data		Blow-on pad 4514 L/R 2100
Label widths operating a HERMES Q2	mm	10 - 58
HERMES Q4/Q4.3	mm	10 - 80
Label heights	mm	10 - 60
State of a product at the moment a label is applied	at rest	■
Label applications	from the top	■
	from below	■
	from the side	■
Product heights	uniform	■
Pivot angle, vertical		120°
Distance between the bottom of the unit and the upper label ending using a cylinder stroke of	200 up to mm	150 ²⁾
	300 up to mm	250 ²⁾
	400 up to mm	350 ²⁾
Compressed air	bar	4.5
Cycle rate ¹⁾	labels/min approx.	20

¹⁾ calculated using a stroke of 100 mm below the unit, labels 40 mm high, a print speed of 100 mm/s

²⁾ depending from the height of a label

Product marking

Flag applicator 4712

Labels can be applied in real time from all sides precisely on round materials such as cables, hoses or pipes.

The pad locates in front of the peel-off plate. It picks up a label while it is being printed. The label is transferred to the spot of application by a stroke cylinder. A further cylinder guides the material all around the material using cam control. First, both endings of a label are stuck together. Then the label is tamped to the round material. The length of the stroke cylinder defines the maximum distance of a product to the peel-off plate.

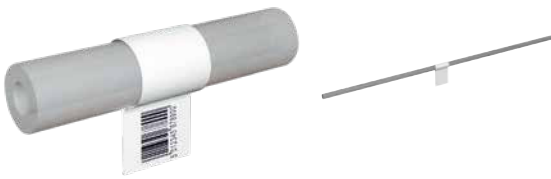

4.6



Accessories

5.13 **Blow tube**

5.14 **Unit to regulate compressed air**

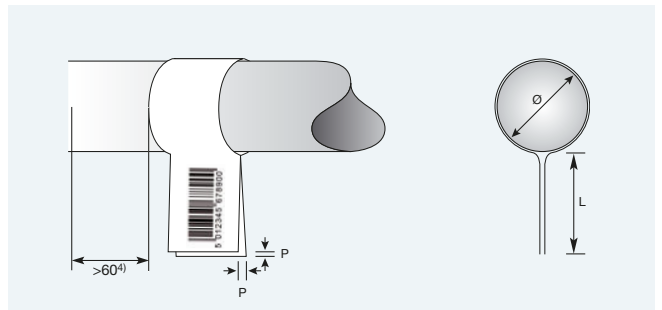
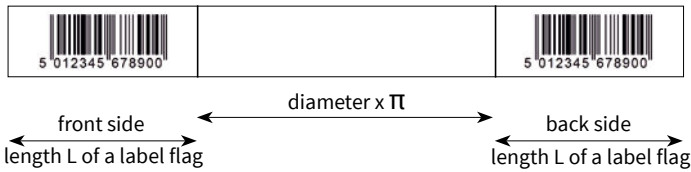

Technical data		Form pad
		4712 L 300
Label widths operating a HERMES Q4L/Q4.3L	mm	50 ¹⁾ - 100
Label heights	mm	10 - 50
Diameter	mm	3 - 16
State of a product at the moment a label is applied	at rest	■
Label applications	from the top	■
	from below	■
	rotated vertically from the side	0 - 180° clockwise (request in case of other rotations)
Product heights	uniform	■
Distance of a product to the bottom of the unit using a cylinder stroke of 300	at least mm	70
	up to mm	260
Depth of pliers immersing	mm	55
Offset P	up to mm	1.0 ²⁾
Compressed air	bar	4.5
Cycle rate, printing and applying only ³⁾ labels/min approx.		15

¹⁾ Processing labels 50 to 58 mm wide requires a spacer.

²⁾ depending from the quality of a label

³⁾ calculated using a print speed of 100 mm/s

⁴⁾ Flag on product requires >60 mm clearance on one side without components, bend or step

Package marking

Front side applicators 3014, 3016

Labels can be applied in real time from the top or the side to packages in motion. Front sides or back sides of a package are preferred.

The pad locates in front of the peel-off plate. It picks up a label while it is being printed. The label is transferred to a product with the help of a rotary cylinder. The package is detected by a sensor and the pivot arm with the pad returned to its initial position.

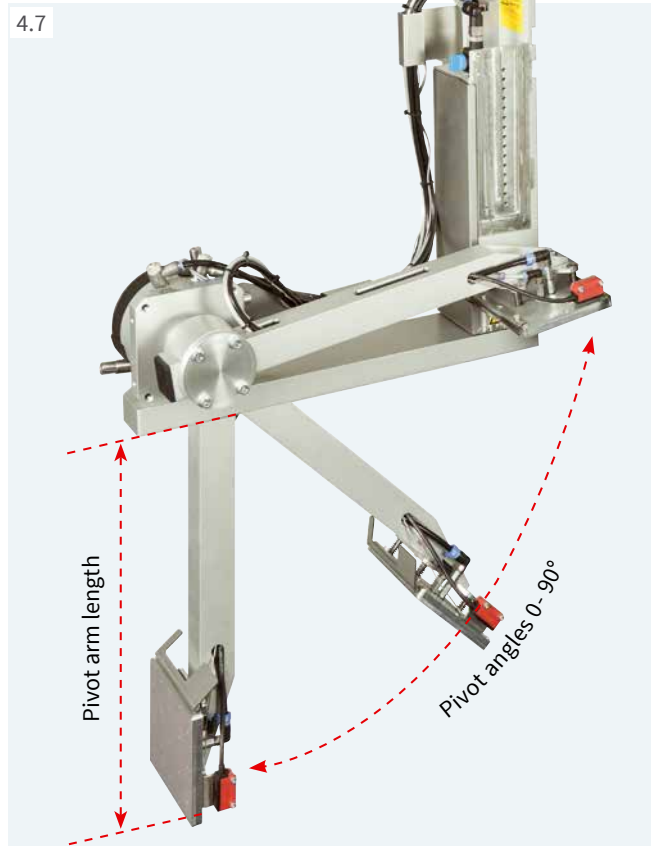
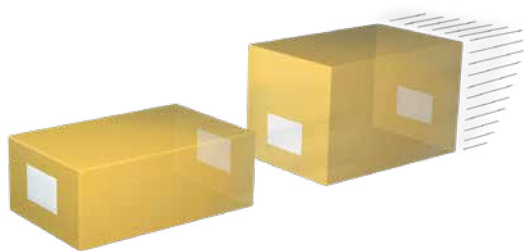

Accessories

5.13 **Blow tube**

5.14 **Unit to regulate compressed air**



Tamp-on pad

Labels are precisely tamped on plane surfaces. Recessed levels are possible as well.



Tamp-on pad, spring-mounted

Labels can be applied to surfaces inclined by a maximum of 15°. Heights within the area of a label may vary by 10 mm at most.



Blow-on pad

Labels are blown on a package surface by a blast of air, bridging a distance of 5 to 10 mm.

		Tamp-on pad 3014, 3016 L/R 1100	Tamp-on pad, spring-mounted 3014, 3016 L/R 3100	Blow-on pad 3014 L/R 2100
Technical data				
Label widths operating a	HERMES Q4/Q4.3 mm	25 - 114	80 - 114	25 - 114
	HERMES Q6.3 mm	25 - 174	80 - 174	-
Label heights operating a	HERMES Q4/Q4.3 mm	8 - 250	80 - 250	10 - 100
	HERMES Q6.3 mm	25 - 250	80 - 250	25 - 100
State of a package	at rest		■	
at the moment a label is applied	in motion		■	
Label applications	from the top		■	
	from the side		■	
	from the front		■	
	from the back		■	
Package heights	variable		■	
Pivot arm lengths ¹⁾	mm		200 / 300 / 400	
Pivot angles			0 - 90°	
Compressed air	bar		4.5	
Cycle rate ²⁾	labels/min approx.		15	

¹⁾ Pivot arm length defines the spot of a label (lower margin) to be reached at 90° below a HERMES Q footprint.

²⁾ calculated using a pivot arm 200 mm long, labels 100 mm high, a print speed of 100 mm/s

Package marking

Stroke applicators 4014, 4016

Labels can be applied in real time from all sides to packages. The type of pad defines whether a package has to be at rest or can be in motion at the time a label is applied.

The pad locates in front of the peel-off plate. It picks up a label while it is being printed. The label is transferred to a package with the help of a stroke cylinder. The package is detected by a sensor and the pad returned to its initial position. The length of the stroke cylinder defines the maximum distance of a package to the peel-off plate.



Accessories

5.13 **Blow tube**

5.14 **Unit to regulate compressed air**

5.17 **Pressure-reducing valve**

4.8



Tamp-on pad

Labels are precisely tamped on plane surfaces. Recessed levels are possible as well.

Universal pad

Labels can be tamped on plane surfaces. Drilled holes are provided in gaps of 5 mm to suck a label. The holes are covered by a sliding foil, but can be opened according to the size of a label using a punching tool. Delivery includes two extra foils.

Tamp-on pad, spring-mounted

Labels can be applied to surfaces inclined by a maximum of 15°. Heights within the area of a label may vary by 10 mm at most.

Universal pad, spring-mounted

Labels can be applied to surfaces inclined by a maximum of 15°. Heights in the area of a label may vary by 10 mm at most. To suck a label, drilled holes are provided in gaps of 5 mm and covered by a sliding foil. Delivery includes two extra foils.

		Tamp-on pad	Universal pad	Tamp-on pad, spring-mounted	Universal pad, spring-mounted
Technical data		4014, 4016 L/R 11 F	4014 L/R 1100	4014, 4016 L/R 3100	4014 L/R 3100
Label widths operating a HERMES Q4/Q4.3	mm	20 - 114	75 / 90	80 - 114	116 / 116
HERMES Q6.3	mm	50 - 174	-	80 - 174	-
Label heights operating a HERMES Q4/Q4.3	mm	20 - 210	60 / 90	80 - 210	102 / 152
HERMES Q6.3	mm	25 - 210	-	80 - 210	-
State of a package at the moment a label is applied	at rest			■	
Label applications	from the top			■	
	from below			■	
	from the side			■	
Package heights	variable			■	
Distance of a package to the bottom of the unit using a cylinder stroke of 200	up to mm	135	135	130	130
	300 up to mm	235	235	230	230
	400 up to mm	335	335	330	330
Depth of a pad immersing F ¹⁾	up to mm	120	-	-	-
Compressed air	bar			4.5	
Cycle rate ²⁾	labels/min approx.			25	

¹⁾ If an applicator immerses more than 25 mm, the cover of HERMES Q must be adapted.

²⁾ calculated using a stroke of 100 mm below the unit, labels 100 mm high, a print speed of 100 mm/s

Package marking

Stroke applicators 4014, 4016

Labels can be applied in real time from all sides to packages. The type of pad defines whether a package has to be at rest or can be in motion at the time a label is applied.

The pad locates in front of the peel-off plate. It picks up a label while it is being printed. The label is transferred to a package with the help of a stroke cylinder. The package is detected by a sensor and the pad returned to its initial position. The length of the stroke cylinder defines the maximum distance of a package to the peel-off plate.

4.8



Accessories

5.13 **Blow tube**

5.14 **Unit to regulate compressed air**

5.17 **Pressure-reducing valve**



Blow-on pad

It benefits when labels have to be applied to sensitive surfaces or packages in motion. Labels are blown on by a blast of air. Stroke cylinder adjustment enables bridging distances of 5 to 10 mm to the surface of a package.

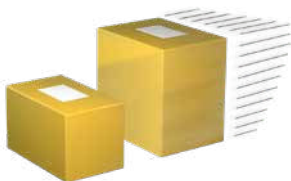

Roll-on pad

Labels are rolled on plane surfaces while these packages are in motion.



Corner-wrap pad

Labels are applied to a package on two sides adjacent to one another. One half of a label is applied to the top of a package. Then the other half of the label is rolled on.

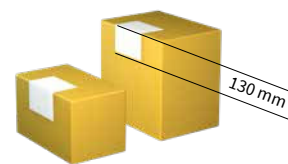

Technical data		Blow-on pad	Roll-on pad	Corner-wrap pad
		4014 L/R 2100	4014, 4016 L/R 4100	4014 L/R 5100
Label widths operating a	HERMES Q4/Q4.3 mm	20 - 114	25 - 114	20 - 114
	HERMES Q6.3 mm	provided on request	50 - 174	-
Label heights operating a	HERMES Q4/Q4.3 mm	20 - 100	80 - 250	60 - 210
	HERMES Q6.3 mm	provided on request	80 - 250	-
State of a package at the moment a label is applied	at rest	■	-	■
	in motion	■	■	-
Label applications	from the top		■	
	from below	■	■	-
	from the side	■	■	-
Package heights	uniform	■	-	-
	variable	-	■	■
Distance of a package to the bottom of the unit using a cylinder stroke of	200 up to mm	140	160	100
	300 up to mm	240	260	200
	400 up to mm	340	360	300
Compressed air	bar		4.5	
Cycle rate ¹⁾	labels/min approx.	25	20	20

¹⁾ calculated using a stroke of 100 mm below the unit, labels 100 mm high, a print speed of 100 mm/s

Package marking

Stroke blow applicator 4614

Labels can be applied in real time from all sides on packages of various heights in motion.

The pad locates in front of the peel-off plate. It picks up a label while it is being printed. Powered by a stroke cylinder and detected by a sensor, the pad moves to a spot approx. 10 mm above a package. The length of the stroke cylinder defines the maximum difference in terms of package heights.

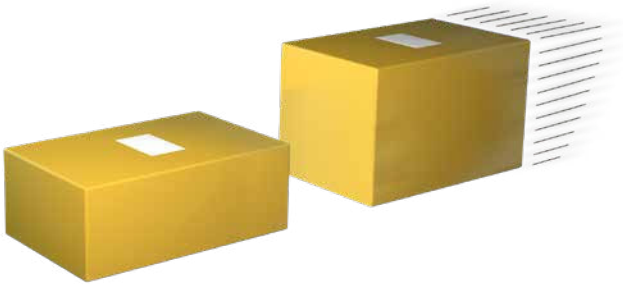

Accessories

5.13 **Blow tube**

5.14 **Unit to regulate compressed air**

4.9



Blow-on pad

Labels are blown on a package surface by a blast of air, bridging a distance of 5 to 10 mm.

Technical data		Blow-on pad 4614 L/R 2100
Label widths operating a	HERMES Q4/Q4.3 mm	20 - 114
	HERMES Q6.3 mm	provided on request
Label heights operating a	HERMES Q4/Q4.3 mm	20 - 100
	HERMES Q6.3 mm	provided on request
State of a package	at rest	■
at the moment a label is applied	in motion	■
Label applications	from the top	■
	from below	■
	from the side	■
Package heights	uniform	■
	variable	■
Distance of a package to the bottom of the unit	using a cylinder stroke of 200	up to mm
	300	up to mm
	400	up to mm
Compressed air	bar	4.5
Cycle rate ¹⁾	labels/min approx.	25

¹⁾ calculated using a stroke of 100 mm below the unit, labels 100 mm high, a print speed of 100 mm/s

Package marking

Demand modules 5112, 5114, 5116

Series of labels can be applied from all sides to packages in motion. The position to which apply a label can be defined on the dispenser tongue using a guide roller.

While a label is applied, the next one is printed simultaneously. Make sure the speed of the conveyor belt corresponds to the print speed.

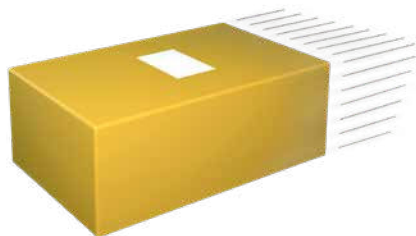

Demand module		5112 L/R	5114 L/R	5116 L/R
Label widths operating a HERMES Q2	mm	10 - 58	-	-
HERMES Q4/Q4.3	mm	-	25 - 114	-
HERMES Q6.3	mm	-	-	46 - 174
Label heights	mm	10 - 250	25 - 250	
Distance of the print line to the peel-off plate	mm	400 - 600		
State of a package at the moment a label is applied	in motion	■		
Label applications	from the top	■		
	from below	■		
	from the side	■		
Package heights	uniform	■		
Distance of a package to the bottom of the unit	mm	80		
Package speeds	mm/s	must correspond to the print speed / 50 - 250 in steps of 25		
Cycle rate ¹⁾	labels/min approx.	60		

¹⁾ calculated using labels 100 mm high and a print speed of 100 mm/s

Package marking

Vacuum belt applicators 5314, 5316

Labels can be applied in real time from all sides on plane surfaces to packages in motion.

The applicator locates in front of the peel-off plate. Printed labels are conveyed by a vacuum belt to the point of transfer to a package. Applying a label is triggered by an external signal.

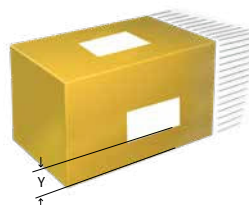
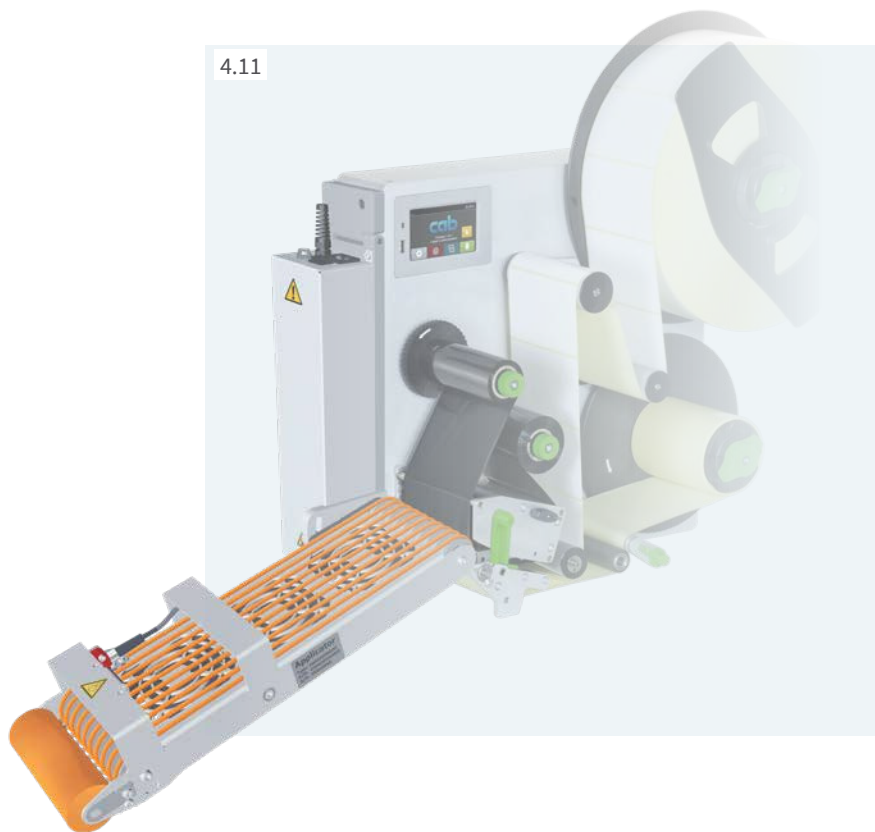

Vacuum belt applicator		5314-3	5316-3
Label applications		on plane surfaces	
Directions to which dispense labels		left and right	
Label widths operating a HERMES Q4/Q4.3	mm	20 - 114	-
HERMES Q6.3	mm	-	46 - 174
Label heights	mm	60 - 356	60 - 356
State of a package at the moment a label is applied in motion		■	
Label applications	from the top	■	
	from below	■	
	from the side	■	
Package heights	uniform	■	
Package speeds	up to m/s	0.5	
Gap between packages	at least m	0.5	
Vacuum belt speed ¹⁾	mm/s	100 - 500	
Cycle rate ²⁾	labels/min up to	30	
Distance of a label to the conveyor belt, when applying from the side	mm	Y = 20	

¹⁾ The speed of a package must be at least as high as the speed of the vacuum belt.

²⁾ calculated using labels 100 mm high and a print speed of 250 mm/s

Package marking

Vacuum belt applicators 5414, 5416

Labels can be applied in real time from all sides on cylindric surfaces, or corner-wrap to packages in motion.

The applicator locates in front of the peel-off plate. Printed labels are conveyed by a vacuum belt to the point of transfer to a package. Applying a label is triggered by an external signal.



Vacuum belt applicator		5414-3	5416-3
Label applications		on cylindric surfaces and corner-wrap	
Directions to which dispense labels		left and right	
Label widths operating a HERMES Q4/Q4.3	mm	20 - 114	-
HERMES Q6.3	mm	-	46 - 174
Label heights	mm	80 - 356	80 - 356
State of a package at the moment a label is applied in motion			■
Label applications	from the top		■
	from the side		■
Package heights	uniform		■
	variable		■
Package speeds	up to m/s		0.3
Gap between packages	at least m		0.5
Steadiness identified at the point a label is transferred			F ¹⁾ = 30 N
Corner-wrap label applications	up to mm		X = 160
Vacuum belt speed ²⁾	mm/s		100 - 300
Cycle rate ³⁾	labels/min up to		15
Distance of a label to the conveyor belt, when applying from the side	mm		Y = 20

¹⁾ F = force required to make the vacuum belt pivot

²⁾ The speed of a package must be at least as high as the speed of the vacuum belt.

³⁾ calculated using labels 100 mm high and a print speed of 250 mm/s

Package marking

Air jet box 6114

Labels can be applied to packages in motion or at rest. Each label is sucked by a fan and blown off by a powerful blast of air coming through aligned nozzles. Depending from the size of a label, a maximum distance of 200 mm can be bridged between a package and the peel-off plate.

Accessories

- 5.13 **Blow tube**
- 5.16 **Unit to regulate compressed air, providing a shut-off valve** to vent a hose line subsequent to the unit; provided in a left-hand or right-hand design



- 1 **Templatee** to cover all the holes sucking or blowing off air outside a label

By holes pre-scored on an 8 x 8 mm pattern, a template can be adapted easily to the size of a label. By sliding in a template between the suction block and rails, the surface outside a label is covered. Scope of delivery includes five templates.

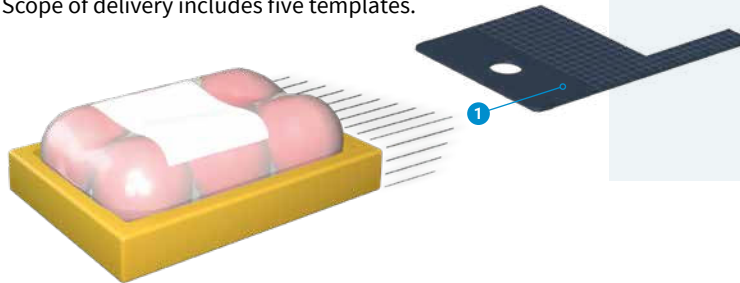

4.13



Air jet box		6114 L/R
Label widths operating a HERMES Q4/Q4.3	mm	50 -114 smaller sizes can be provided on request
Label heights	mm	50 -125 smaller sizes can be provided on request
State of a package at the moment a label is applied	at rest in motion	■ ■
Label application	from the top from below from the side	■ ■ ■
Package heights	variable	■
Distance of a package to the peel-off plate up to mm		200
Compressed air	bar	4.5 - 6
Cycle rate ¹⁾	labels/min up to	100

¹⁾ calculated using labels 50 mm high, a print speed of 250 mm/s, a blast of air lasting 100 ms, with packages located 100 mm to the peel-off plate.

Accessories and options provided for applicators

■ standard □ option

Pos.	Designation	4.1 3214	4.2 4114/16	4.3 4214	4.4 4414	4.5 4514	4.6 4712	4.7 3014/16	4.8 4014/16	4.9 4614	4.13 6114
5.13	Blow tube	■	■	■	■	■	■	■	■	■	■
5.14	Unit to regulate compressed air	□	□	□	□	□	□	□	□	□	□
5.16	Unit to regulate compressed air, providing a shut-off valve	-	-	-	-	-	-	-	-	-	□
5.17	Pressure-reducing valve	-	□	□	□	-	-	-	□	-	-



Blow tube
to provide support air. To assist label transfer, the label is blown from below to the pad.
Provided for 2", 4" or 6" label applications



Unit to regulate compressed air
4.5 bar default setting
Provided in a left-hand or right-hand design
Delivery includes a fine filter, a pressure control valve with a display, a hose to connect to an applicator's compressed air input and material to assemble the unit to a chassis or a bracket.



Unit to regulate compressed air, providing a shut-off valve
to vent a hose line subsequent to the unit
Provided in a left-hand or right-hand design



Pressure-reducing valve
It reduces the pressure exerted by the stroke cylinder to a product.
Designed for applicators 4014/16, 4114/16, 4214, 4414

Examples how to assemble a unit to regulate compressed air

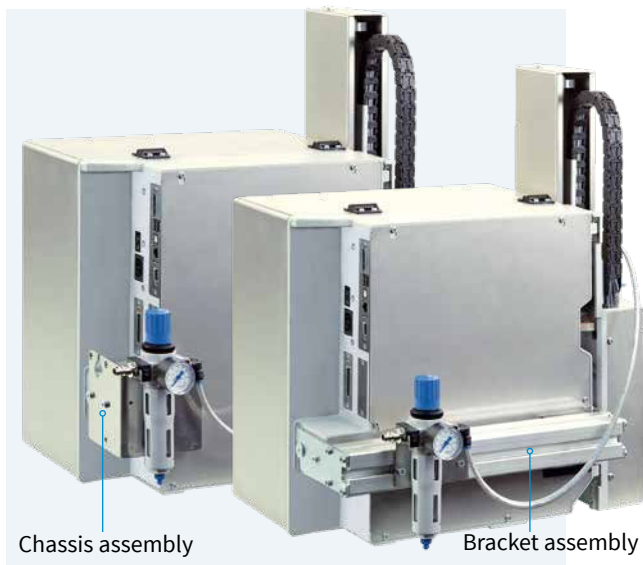

Tools to assemble HERMES Q

Pos.	Designation	1.1	1.2		1.3
		HERMES Q2	HERMES Q4.3	HERMES Q4	HERMES Q6.3
6.1	Adapter plate	<input type="checkbox"/>	<input type="checkbox"/>	<input type="checkbox"/>	<input type="checkbox"/>
6.2	Profiles 40, 80, 120 mm	<input type="checkbox"/>	<input type="checkbox"/>	<input type="checkbox"/>	<input type="checkbox"/>
6.3	Base plate 500 x 255 mm	<input type="checkbox"/>	<input type="checkbox"/>	<input type="checkbox"/>	-
6.4	Mounting plate	<input type="checkbox"/>	<input type="checkbox"/>	<input type="checkbox"/>	<input type="checkbox"/>
6.5	Bracket	<input type="checkbox"/>	<input type="checkbox"/>	<input type="checkbox"/>	<input type="checkbox"/>
6.6	Clamped joint designed for a 50 x 50 mm profile	<input type="checkbox"/>	<input type="checkbox"/>	<input type="checkbox"/>	<input type="checkbox"/>
6.7	Flanged joint designed for a 50 x 50 mm profile	<input type="checkbox"/>	<input type="checkbox"/>	<input type="checkbox"/>	<input type="checkbox"/>
6.8	Floor stand 1601	<input type="checkbox"/>	<input type="checkbox"/>	<input type="checkbox"/>	<input type="checkbox"/>
6.9	Floor stand 1602	<input type="checkbox"/>	<input type="checkbox"/>	<input type="checkbox"/>	<input type="checkbox"/>
6.10	Floor stand 1201	<input type="checkbox"/>	<input type="checkbox"/>	<input type="checkbox"/>	<input type="checkbox"/>

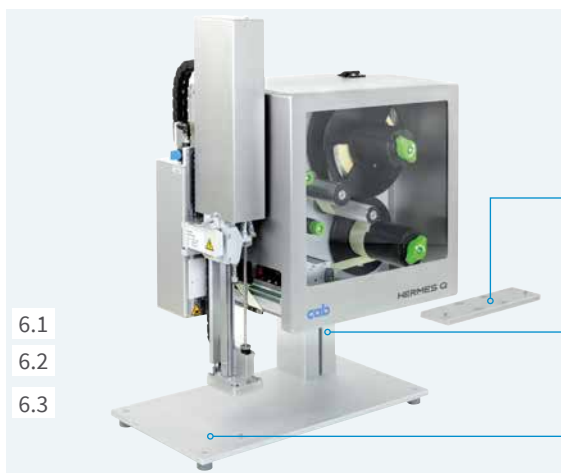

Mount

to install on a table or to a production line.
Provided in a left-hand or right-hand design

The size of the mount can be adapted to an application.

1 Adapter plate

to fix a label application system.
Alternatively, it can be assembled directly to a production line, using the adapter plate with a profile.

2 Profile

square aluminum; 40, 80, 120 mm are standards,
further lengths can be provided on request

3 Base plate

to fix the product jig; 500 x 255 mm by default

Mounting plate

to assemble directly to a production line

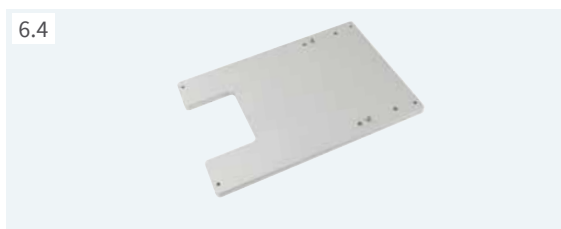

Bracket

to assemble to a floor stand



Clamped joint designed for a 50 x 50 mm profile

to move in horizontal or vertical direction

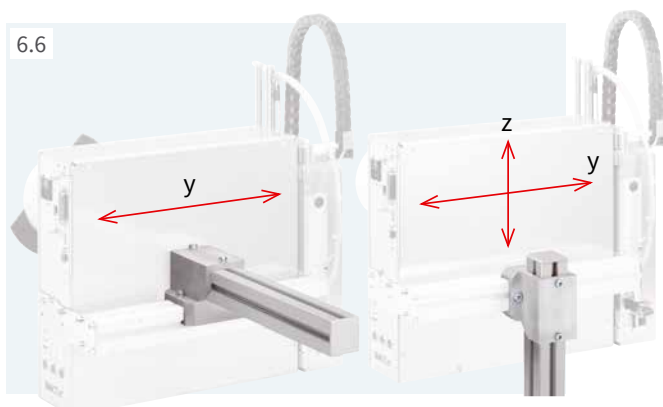

Flanged joint designed for a 50 x 50 mm profile

to move in horizontal direction or rotate around an axis

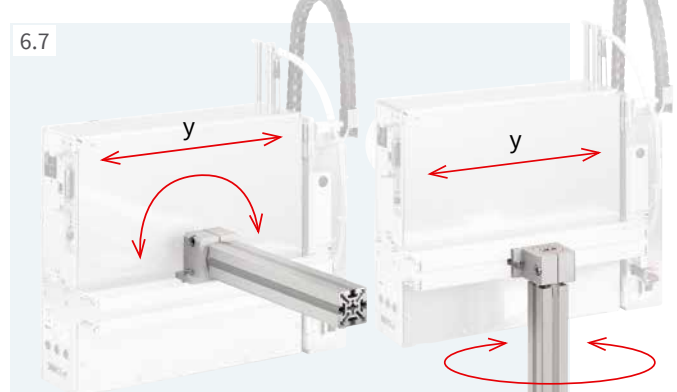

HERMES Q floor stands

HERMES Q can be installed to a production line and aligned in three axes to the product to label. Pivoting is also possible.

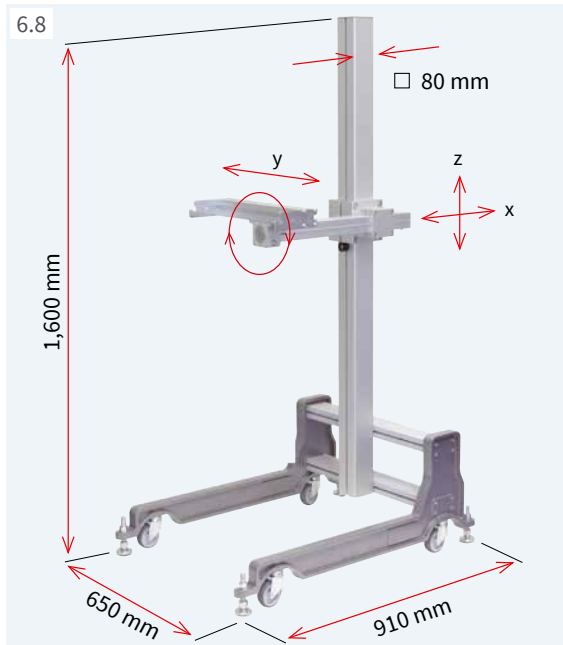

Floor stand 1601

It benefits when operating HERMES Q in different production lines. Mobility is provided. At the place of operation, the floor stand can be fixed with the help of feet to adjust.

Floor stand	1601
Base frame	castors, feet
Adjustment of heights and depths	screw clamping
Load if offset is 500 mm	up to kg
Weight	kg

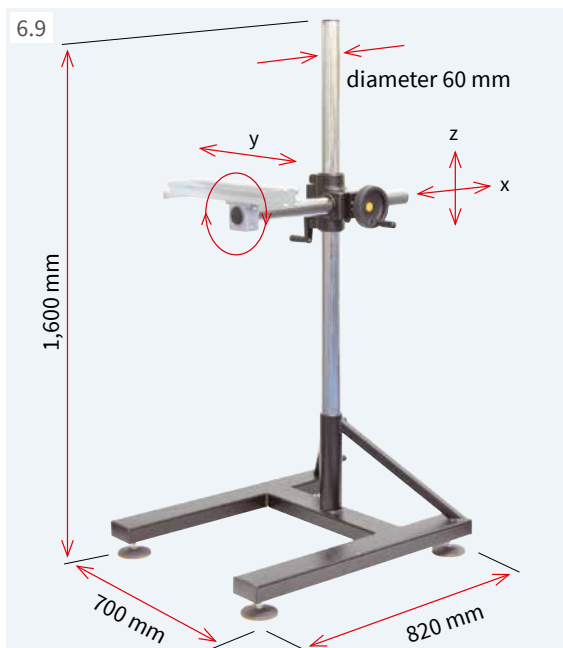

Floor stand 1602

It benefits if positions to apply labels are changing frequently in terms of heights and depths. HERMES Q can be aligned in directions x and z to a product using a toothed rack.

Floor stand	1602
Base frame	feet
Adjustment of heights and depths	toothed rack, crank toothed rack, handwheel
Load if offset is 500 mm	up to kg
Weight	kg

Examples how to assemble to a stand

Applying labels in direction of transport from the top from the side

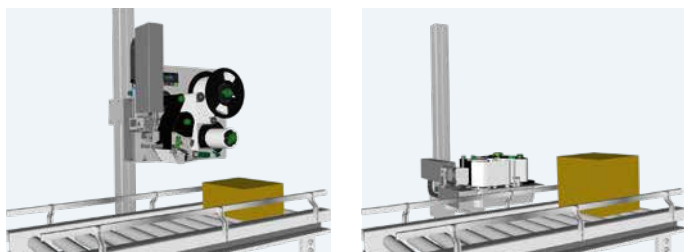

Applying labels crosswise the direction of transport from the top from the side

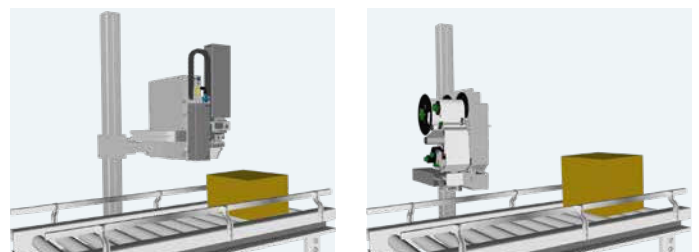

HERMES Q floor stand

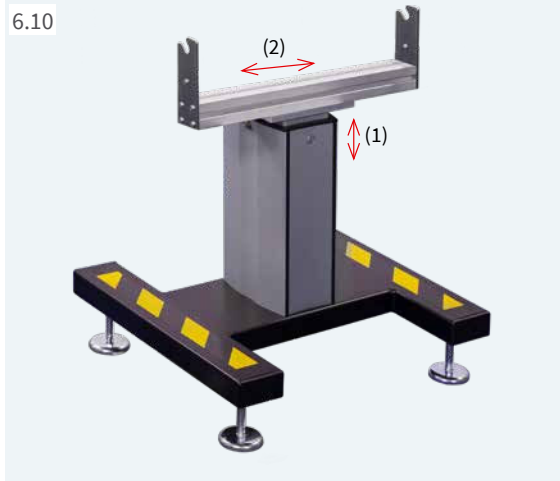

Floor stand 1201

to assemble HERMES Q horizontally in a production line.

The height can be adjusted continuous using an integral spindle.

A unit to regulate compressed air can be assembled to the bracket, so can a warning light.

Floor stand		1201
Feet to adjust	by mm	± 15
Load	up to kg	75
(1) Lower label margin-floor ¹⁾	mm	720-960
(2) Depth along direction of transport	mm	± 100
Weight	approx. kg	40

¹⁾ further dimensions can be provided on request

HERMES Q delivery program

Label printers L

Pos.	Part no.	Designation
1.1	6010003	Label printer HERMES Q2L/300-2
	6010004	Label printer HERMES Q2L/600-2
1.2	6010005	Label printer HERMES Q4L/300-2
	6010006	Label printer HERMES Q4L/600-2
	6010007	Label printer HERMES Q4.3L/200-2
	6010008	Label printer HERMES Q4.3L/300-2
1.3	6010009	Label printer HERMES Q6.3L/200-2
	6010010	Label printer HERMES Q6.3L/300-2
1.1	6010011	Label printer HERMES Q2L/300-3
	6010012	Label printer HERMES Q2L/600-3
1.2	6010013	Label printer HERMES Q4L/300-3
	6010014	Label printer HERMES Q4L/600-3
	6010015	Label printer HERMES Q4.3L/200-3
	6010016	Label printer HERMES Q4.3L/300-3
1.3	6010017	Label printer HERMES Q6.3L/200-3
	6010018	Label printer HERMES Q6.3L/300-3

xxxxxxx.250 if HERMES Q provides options

Label printers R

Pos.	Part no.	Designation
1.1	6010023	Label printer HERMES Q2R/300-2
	6010024	Label printer HERMES Q2R/600-2
1.2	6010025	Label printer HERMES Q4R/300-2
	6010026	Label printer HERMES Q4R/600-2
	6010027	Label printer HERMES Q4.3R/200-2
	6010028	Label printer HERMES Q4.3R/300-2
1.3	6010029	Label printer HERMES Q6.3R/200-2
	6010030	Label printer HERMES Q6.3R/300-2
1.1	6010031	Label printer HERMES Q2R/300-3
	6010032	Label printer HERMES Q2R/600-3
1.2	6010033	Label printer HERMES Q4R/300-3
	6010034	Label printer HERMES Q4R/600-3
	6010035	Label printer HERMES Q4.3R/200-3
	6010036	Label printer HERMES Q4.3R/300-3
1.3	6010037	Label printer HERMES Q6.3R/200-3
	6010038	Label printer HERMES Q6.3R/300-3

xxxxxxx.250 if HERMES Q provides options

Scope of HERMES Q label printer delivery

HERMES Q label printer
Power cable Type E+F, 1.8 m
Connecting USB cable, 1.8 m
Assembly instructions DE/EN

Available online



<https://setup.cab.de/en>

Assembly instructions DE/EN/FR
Configuration manuals DE/EN/FR
Service manuals DE/EN
Spare parts lists DE/EN
Programming manual EN
Windows printer drivers WHQL-certified for
Windows Vista Server 2008
Windows 7 Server 2008 R2
Windows 8 Server 2012
Windows 8.1 Server 2012 R2
Windows 10 Server 2016
Server 2019
Apple Mac OS X printer drivers DE/EN/FR
Linux printer drivers DE/EN/FR
cablabel S3 Lite software
cablabel S3 Viewer
Database Connector

Options

Pos.	Part no.	Designation
3.1	6010860.250	Automatic ribbon saving 4L
	6010861.250	Automatic ribbon saving 6L
	6010862.250	Automatic ribbon saving 4R
	6010863.250	Automatic ribbon saving 6R
3.2	6010591.xxx	Label unwinder K40/2-2
	6010592.xxx	Label unwinder K40/4-2
	6010593.xxx	Label unwinder K40/6-2
	6010594.xxx	Label unwinder K40/2-3
3.3	6010595.xxx	Label unwinder K40/4-3
	6010596.xxx	Label unwinder K40/6-3
	5961406.xxx	Adapter 40/50
3.4	5961262.xxx	Adapter 76/100
3.5	6010586.xxx	Spacer L
	6010590.xxx	Spacer R
3.6	5961650.xxx	Margin stop 10
	6010500.xxx	Cover 2L
3.7	6010501.xxx	Cover 4L
	5983108.xxx	Cover 4L for flag applicator 4712 operation
	6010502.xxx	Cover 6L
	6010503.xxx	Cover 2R
3.8	6010504.xxx	Cover 4R
	6010505.xxx	Cover 6R
	6010840.xxx	Print head pressure system 2L
3.9	6010841.xxx	Print head pressure system 4L
	6010842.xxx	Print head pressure system 6L
	6010843.xxx	Print head pressure system 2R
	6010844.xxx	Print head pressure system 4R
3.10	6010845.xxx	Print head pressure system 6R
	6010557.xxx	Extended peel-off plate (+10 mm) 2L
	6010558.xxx	Extended peel-off plate (+10 mm) 4L
3.11	6010559.xxx	Extended peel-off plate (+10 mm) 6L
	6010563.xxx	Extended peel-off plate (+10 mm) 2R
	6010564.xxx	Extended peel-off plate (+10 mm) 4R
3.12	6010565.xxx	Extended peel-off plate (+10 mm) 6R
	5954978.xxx	Print roller DRS2
	5954985.xxx	Print roller DRS4
3.13	5954979.xxx	Print roller DRS6
	5961640.xxx	Antistatic brush 2L
3.14	5961644.xxx	Antistatic brush 4L
	5961642.xxx	Antistatic brush 2R
	5961646.xxx	Antistatic brush 4R
3.15	5961750.xxx	Draw roller ZS2
	5961751.xxx	Draw roller ZS4
	5961752.xxx	Draw roller ZS6
3.16	6010520.xxx	2 port Ethernet switch 10/100 Mbit/s
	5977487.xxx	Label sensor L, modified
3.17	6010498.xxx	Label sensor R, modified















xxx - .250 assembled to the printer
.001 delivered separately



Information is available also on the Internet:
www.cab.de/en/hermesq

HERMES Q delivery program

Accessories

Pos.	Part no.	Designation
2.1	 5977370	SD memory card
2.2	 5977730	USB memory stick
2.3	 5978912	USB WLAN stick 2.4 GHz 802.11b/g/n
2.4	 5977731	USB WLAN stick including a rod antenna 2.4 GHz 802.11b/g/n + 5 GHz a/n/ac
2.5	 5977732	USB Bluetooth adapter
2.6	 5970071	Product sensor, 3 pins
2.7	 5964300	Product sensor, 25 pins
2.8	 5917651	I/O interface connector SUB-D, 25 pins
2.9	 6010560	Warning light <i>Available again as of quarter 1/2023</i>
2.10	 6010186	External operation panel
	5907718.850	Connecting USB cable, 1.8 m
	5907730.850	Connecting USB cable, 3 m
	5907750.850	Connecting USB cable, 5 m
	5907760.850	Connecting USB cable, 11 m
5907765.850	Connecting USB cable, 16 m	
2.11	 5948205	Label selection - I/O box
2.12	 5955710	Hand switch TR2
2.13	 5955711	Foot switch
2.14	 5550818	Connecting RS232 C cable 9/9 pins, 3 m
2.15	 on request	Scanner CC200

Label software

Pos.	Part no.	Designation
7.6	Bundle	cablabel S3 Lite (download on cab.de/en)
	5588001	cablabel S3 Pro, 1 WS
	5588100	cablabel S3 Pro, 5 WS
	5588101	cablabel S3 Pro, 10 WS
	5588150	cablabel S3 Pro, 1 additional licence
	5588151	cablabel S3 Pro, 4 additional licences
	5588152	cablabel S3 Pro, 9 additional licences
	5588002	cablabel S3 Print, 1 WS
	5588105	cablabel S3 Print, 5 WS
	5588106	cablabel S3 Print, 10 WS
7.10	5588155	cablabel S3 Print, 1 additional licence
	5588156	cablabel S3 Print, 4 additional licences
	5588157	cablabel S3 Print, 9 additional licences
	in preparation	cablabel S3 Print Server
	9008486	Programming manual EN, printed copy

Wear parts















Pos.	Part no.	Designation	dpi
	5977384.001	Print head 2	300
	5977385.001	Print head 2	600
	5977444.001	Print head 4	300
	5977380.001	Print head 4	600
	5977382.001	Print head 4.3	200
	5977383.001	Print head 4.3	300
	5977386.001	Print head 6.3	200
	5977387.001	Print head 6.3	300
	5954102.001	Print roller DR2	
	5954180.001	Print roller DR4	
	5954245.001	Print roller DR6	
	5961015.001	Draw roller ZR2	
	5961298.001	Draw roller ZR4	
	5961220.001	Draw roller ZR6	

User languages

Language	Assembly instructions	Control panel	Windows driver	cablabel S3
European Union				
Bulgarian		X		X
Danish	X	X	X	
German	X	X	X	X
English	X	X	X	X
Estonian		X		
Finnish	X	X	X	
French	X	X	X	X
Greek		X		
Italian	X	X	X	X
Croatian		X	X	
Latvian		X		
Lithuanian		X	X	
Dutch	X	X	X	
Polish	X	X	X	X
Portuguese	X	X	X	
Romanian	X	X		
Swedish	X	X	X	
Slovak		X	X	
Slovenian	X	X	X	
Spanish	X	X	X	X
Czech	X	X	X	X
Hungarian	X	X	X	
Europe (Non-EU)				
Macedonian		X		
Norwegian		X	X	
Russian	X	X	X	X
Serbian		X		
Turkish		X	X	
Asia				
Chinese, simplified	X	X	X	X
Chinese, traditional	X	X	X	X
Japanese			X	
Korean	X		X	X
Thai		X	X	
Middle East				
Arabian		X		
Hebrew			X	
Persian		X		











HERMES Q delivery program

Applicators L

Pos.	Part no.	Designation	Part no.	Transfer modules
4.1	 5970075	Swing applicator 3214L-40	xxxxxxx xxxxxxx xxxxxxx xxxxxxx	Tamp-on pad Tamp-on pad, providing a damping layer Tamp-on pad, providing a label stop Blow-on pad 3214L-11 F W x H 3214L-12 F W x H 3214L-61 F W x H 3214L-2100 W x H
4.2	 5966109 5966110 5966111	Stroke applicator 4114L-200	xxxxxxx	Tamp-on pad 4114L-11 F W x H
		Stroke applicator 4114L-300	xxxxxxx	Tamp-on pad, providing a damping layer 4114L-12 F W x H
4.2	 5971795 5972016 5972017	Stroke applicator 4116L-200	xxxxxxx	Tamp-on pad, providing a label stop 4114L-61 F W x H
		Stroke applicator 4116L-300	xxxxxxx	Blow-on pad 4114L-2100 W x H
		Stroke applicator 4116L-400	xxxxxxx	Form pad 4114L-8800 W x H
4.3	 5966117 5966118 5966119	Stroke turn applicator 4214L-200	xxxxxxx	Tamp-on pad 4214L-11 F W x H
		Stroke turn applicator 4214L-300	xxxxxxx	Tamp-on pad, providing a damping layer 4214L-12 F W x H
		Stroke turn applicator 4214L-400	xxxxxxx	Tamp-on pad, providing a label stop 4214L-61 F W x H Blow-on pad 4214L-2100 W x H
4.4	 5966133 5966134 5966135	Stroke applicator 4414L-200	xxxxxxx	Tamp-on pad 4414L-11 F W x H
		Stroke applicator 4414L-300	xxxxxxx	Tamp-on pad, providing a damping layer 4414L-12 F W x H
		Stroke applicator 4414L-400	xxxxxxx	Tamp-on pad, providing a label stop 4414L-61 F W x H
4.5	 5971625 5966168 5971640	Swing stroke applicator 4514L-200 Swing stroke applicator 4514L-300 Swing stroke applicator 4514L-400	xxxxxxx	Blow-on pad 4514L-2100 W x H
4.6	 5971815	Flag applicator 4712L-300	xxxxxxx	Form pad W x H
4.7	 5970100 5970101 5970102	Front side applicator 3014L-200 Front side applicator 3014L-300 Front side applicator 3014L-400	xxxxxxx xxxxxxx xxxxxxx	Tamp-on pad Tamp-on pad, spring-mounted Blow-on pad 3014L-1100 W x H 3014L-3100 W x H 3014L-2100 W x H
		5970103 5970104 5970105	Front side applicator 3016L-200 Front side applicator 3016L-300 Front side applicator 3016L-400	xxxxxxx xxxxxxx
4.8	 5966101 5966102 5966103	Stroke applicator 4014L-200	5966147 5966148 5966149 5966150	Universal pad Universal pad Universal pad, spring-mounted Universal pad, spring-mounted 4014L-1100 75 x 60 4014L-1100 90 x 90 4014L-3100 116 x 102 4014L-3100 116 x 152
			xxxxxxx xxxxxxx xxxxxxx xxxxxxx	Tamp-on pad Blow-on pad Tamp-on pad, spring-mounted Roll-on pad Corner-wrap pad 4014L-11 F W x H 4014L-2100 W x H 4014L-3100 W x H 4014L-4100 W x H 4014L-5100 W x H / H
		5966161 5966162 5966163	Stroke applicator 4016L-200 Stroke applicator 4016L-300 Stroke applicator 4016L-400	xxxxxxx xxxxxxx xxxxxxx
4.9	 5971720 5971725 5971730	Stroke blow applicator 4614L-200 Stroke blow applicator 4614L-300 Stroke blow applicator 4614L-400	xxxxxxx	Blow-on pad 4614L-2100 W x H
4.10	 6010890 5966144 5966146	Demand module 5112L Demand module 5114L Demand module 5116L		
4.11	 5972730 5972750	Vacuum belt applicator 5314L-3 Vacuum belt applicator 5316L-3		
4.12	 5972940 5972920	Vacuum belt applicator 5414L-3 Vacuum belt applicator 5416L-3		
4.13	 5984810	Air jet box 5 templates are included 6114L	5984709.001	Template 5 items are included in a pack unit 6114 L/R



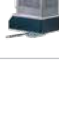

HERMES Q delivery program

Applicators R







Pos.	Part no.	Designation	Part no.	Transfer modules
4.1	 5971655	Swing applicator 3214R-40	xxxxxxx xxxxxxx xxxxxxx xxxxxxx	Tamp-on pad Tamp-on pad, providing a damping layer Tamp-on pad, providing a label stop Blow-on pad 3214R-11 F W x H 3214R-12 F W x H 3214R-61 F W x H 3214R-2100 W x H
4.2	 5966113 5966114 5966115	Stroke applicator Stroke applicator Stroke applicator 4114R-200 4114R-300 4114R-400	xxxxxxx xxxxxxx xxxxxxx xxxxxxx xxxxxxx	Tamp-on pad Tamp-on pad, providing a damping layer Tamp-on pad, providing a label stop Blow-on pad Form pad 4114R-11 F W x H 4114R-12 F W x H 4114R-61 F W x H 4114R-2100 W x H 4114R-8800 W x H
	5972018 5972019 5972020	Stroke applicator Stroke applicator Stroke applicator 4116R-200 4116R-300 4116R-400	xxxxxxx xxxxxxx xxxxxxx xxxxxxx	Tamp-on pad Tamp-on pad, providing a damping layer Tamp-on pad, providing a label stop Form pad 4116R-11 F W x H 4116R-12 F W x H 4116R-61 F W x H 4116R-8800 W x H
4.3	 5966121 5966122 5966123	Stroke turn applicator Stroke turn applicator Stroke turn applicator 4214R-200 4214R-300 4214R-400	xxxxxxx xxxxxxx xxxxxxx xxxxxxx	Tamp-on pad Tamp-on pad, providing a damping layer Tamp-on pad, providing a label stop Blow-on pad 4214R-11 F W x H 4214R-12 F W x H 4214R-61 F W x H 4214R-2100 W x H
4.4	 5966137 5966138 5966139	Stroke applicator Stroke applicator Stroke applicator 4414R-200 4414R-300 4414R-400	xxxxxxx xxxxxxx xxxxxxx	Tamp-on pad Tamp-on pad, providing a damping layer Tamp-on pad, providing a label stop 4414R-11 F W x H 4414R-12 F W x H 4414R-61 F W x H
4.5	 5966950 5971460 5971700	Swing stroke applicator Swing stroke applicator Swing stroke applicator 4514R-200 4514R-300 4514R-400	xxxxxxx	Blow-on pad 4514R-2100 W x H
4.7	 5970106 5970107 5970108	Front side applicator Front side applicator Front side applicator 3014R-200 3014R-300 3014R-400	xxxxxxx xxxxxxx xxxxxxx	Tamp-on pad Tamp-on pad, spring-mounted Blow-on pad 3014R-1100 W x H 3014R-3100 W x H 3014R-2100 W x H
	5970109 5970110 5970111	Front side applicator Front side applicator Front side applicator 3016R-200 3016R-300 3016R-400	xxxxxxx xxxxxxx	Tamp-on pad Tamp-on pad, spring-mounted 3016R-1100 W x H 3016R-3100 W x H
4.8	 5966105 5966106 5966107	Stroke applicator Stroke applicator Stroke applicator 4014R-200 4014R-300 4014R-400	5966140 5966141 5966142 5966143	Universal pad Universal pad Universal pad, spring-mounted Universal pad, spring-mounted 4014R-1100 75 x 60 4014R-1100 90 x 90 4014R-3100 116 x 102 4014R-3100 116 x 152
	5966165 5966166 5966167	Stroke applicator Stroke applicator Stroke applicator 4016R-200 4016R-300 4016R-400	xxxxxxx xxxxxxx xxxxxxx	Tamp-on pad Tamp-on pad, spring-mounted Roll-on pad 4016R-11 F W x H 4016R-3100 W x H 4016R-4100 W x H
4.9	 5971735 5971740 5971745	Stroke blow applicator Stroke blow applicator Stroke blow applicator 4614R-200 4614R-300 4614R-400	xxxxxxx	Blow-on pad 4614R-2100 W x H
4.10	 6010910 5966145 5966152	Demand module Demand module Demand module 5112R 5114R 5116R		
4.11	 5972740 5972760	Vacuum belt applicator Vacuum belt applicator 5314R-3 5316R-3		
4.12	5972950 5972930	Vacuum belt applicator Vacuum belt applicator 5414R-3 5416R-3		
4.13	 5984800	Air jet box 5 templates are included 6114R	5984709.001	Template 5 items are included in a pack unit 6114 L/R

xxxxxxx - customer-specific part no. subsequent to request

Accessories and options provided for applicators

Pos.		Part no.	Designation
5.13		5964277.001 5964095.001 5964614.001	Blow tube 2" Blow tube 4" Blow tube 6"
5.14		6010880 6010881	Unit L to regulate compressed air Unit R to regulate compressed air
5.16		5984805 5984795	Unit L to regulate compressed air, providing a shut-off valve Unit R to regulate compressed air, providing a shut-off valve
5.17		596xxxx.212	Pressure-reducing valve
		xxxx - applicator part no.	

Tools to assemble

Pos.		Part no.	Designation
6.1		5965940	Adapter plate
6.2		on request	Profile (customer-specific lengths)
6.3		5961203	Base plate 500 x 255 mm
6.4		5958400	Mounting plate
6.5		5955685	Bracket
6.6		8914443	Clamped joint designed for a 50 x 50 mm profile
6.7		8914444	Flanged joint designed for a 50 x 50 mm profile

Floor stands

Pos.		Part no.	Designation
6.8		5970113	Floor stand 1601
6.9		5970112	Floor stand 1602
6.10		5972515	Floor stand 1201

cab product overview

Label printers
MACH1, MACH2



Label printers
EOS 2



Label printers
EOS 5



Label printers
MACH 4S



Label printers
SQUIX 2



Label printers
SQUIX 4



Label printers
SQUIX 6.3



Label printers
SQUIX 8.3



Label printers
XD Q double-sided



Label printers
XC two-colored



Print and apply systems
HERMES Q



Print and apply systems
Hermes C two-colored

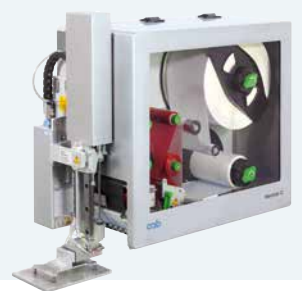

Tube labeling systems
AXON 1



Print modules
PX Q



Labels and ribbons



Label software
cablabel S3



Label dispensers
HS, VS



Labeling heads
IXOR



Marking lasers
XENO 4



Laser marking systems



Germany
cab Produkttechnik GmbH & Co KG
Karlsruhe
Phone +49 721 6626 0
www.cab.de

France
cab Technologies S.à.r.l.
Niedermodern
Phone +33 388 722501
www.cab.de/fr

USA
cab Technology, Inc.
Chelmsford, MA
Phone +1 978 250 8321
www.cab.de/us

Mexico
cab Technology, Inc.
Juárez
Phone +52 656 682 4301
www.cab.de/es

Taiwan
cab Technology Co., Ltd.
Taipei
Phone +886 (02) 8227 3966
www.cab.de/tw

China
cab (Shanghai) Trading Co., Ltd.
Shanghai
Phone +86 (021) 6236 3161
www.cab.de/cn

Singapore
cab Singapore Pte. Ltd.
Singapore
Phone +65 6931 9099
www.cab.de/en

South Africa
cab Technology (Pty) Ltd.
Randburg
Phone +27 11 886 3580
www.cab.de/za

cab // 820 distribution partners in more than 80 countries

cab
we identify more